

⚠ WARNING

⚠ CALIFORNIA PROPOSITION 65 WARNINGS ⚠

Diesel engine exhaust and some of its constituents are known to the State of California to cause cancer, birth defects, and other reproductive harm.

The Above For Diesel Engines

The engine exhaust from this product contains chemicals known to the State of California to cause cancer, birth defects, or other reproductive harm.

The Above For Gasoline Engines

ARC WELDING CAN BE HAZARDOUS. PROTECT YOURSELF AND OTHERS FROM POSSIBLE SERIOUS INJURY OR DEATH. KEEP CHILDREN AWAY. PACEMAKER WEARERS SHOULD CONSULT WITH THEIR DOCTOR BEFORE OPERATING.

Read and understand the following safety highlights. For additional safety information, it is strongly recommended that you purchase a copy of "Safety in Welding & Cutting - ANSI Standard Z49.1" from the American Welding Society, P.O. Box 351040, Miami, Florida 33135 or CSA Standard W117.2-1974. A Free copy of "Arc Welding Safety" booklet E205 is available from the Lincoln Electric Company, 22801 St. Clair Avenue, Cleveland, Ohio 44117-1199.

BE SURE THAT ALL INSTALLATION, OPERATION, MAINTENANCE AND REPAIR PROCEDURES ARE PERFORMED ONLY BY QUALIFIED INDIVIDUALS.



FOR ENGINE powered equipment.

1.a. Turn the engine off before troubleshooting and maintenance work unless the maintenance work requires it to be running.



1.b. Operate engines in open, well-ventilated areas or vent the engine exhaust fumes outdoors.



1.c. Do not add the fuel near an open flame welding arc or when the engine is running. Stop the engine and allow it to cool before refueling to prevent spilled fuel from vaporizing on contact with hot engine parts and igniting. Do not spill fuel when filling tank. If fuel is spilled, wipe it up and do not start engine until fumes have been eliminated.

1.d. Keep all equipment safety guards, covers and devices in position and in good repair. Keep hands, hair, clothing and tools away from V-belts, gears, fans and all other moving parts when starting, operating or repairing equipment.

1.e. In some cases it may be necessary to remove safety guards to perform required maintenance. Remove guards only when necessary and replace them when the maintenance requiring their removal is complete. Always use the greatest care when working near moving parts.



1.f. Do not put your hands near the engine fan. Do not attempt to override the governor or idler by pushing on the throttle control rods while the engine is running.

1.g. To prevent accidentally starting gasoline engines while turning the engine or welding generator during maintenance work, disconnect the spark plug wires, distributor cap or magneto wire as appropriate.



1.h. To avoid scalding, do not remove the radiator pressure cap when the engine is hot.



ELECTRIC AND MAGNETIC FIELDS may be dangerous

2.a. Electric current flowing through any conductor causes localized Electric and Magnetic Fields (EMF). Welding current creates EMF fields around welding cables and welding machines

2.b. EMF fields may interfere with some pacemakers, and welders having a pacemaker should consult their physician before welding.

2.c. Exposure to EMF fields in welding may have other health effects which are now not known.

2.d. All welders should use the following procedures in order to minimize exposure to EMF fields from the welding circuit:

2.d.1. Route the electrode and work cables together - Secure them with tape when possible.

2.d.2. Never coil the electrode lead around your body.

2.d.3. Do not place your body between the electrode and work cables. If the electrode cable is on your right side, the work cable should also be on your right side.

2.d.4. Connect the work cable to the workpiece as close as possible to the area being welded.

2.d.5. Do not work next to welding power source.

Mar '95



ELECTRIC SHOCK can kill.

- 3.a. The electrode and work (or ground) circuits are electrically "hot" when the welder is on. Do not touch these "hot" parts with your bare skin or wet clothing. Wear dry, hole-free gloves to insulate hands.
- 3.b. Insulate yourself from work and ground using dry insulation. Make certain the insulation is large enough to cover your full area of physical contact with work and ground.
- In addition to the normal safety precautions, if welding must be performed under electrically hazardous conditions (in damp locations or while wearing wet clothing; on metal structures such as floors, gratings or scaffolds; when in cramped positions such as sitting, kneeling or lying, if there is a high risk of unavoidable or accidental contact with the workpiece or ground) use the following equipment:**
- Semiautomatic DC Constant Voltage (Wire) Welder.
 - DC Manual (Stick) Welder.
 - AC Welder with Reduced Voltage Control.
- 3.c. In semiautomatic or automatic wire welding, the electrode, electrode reel, welding head, nozzle or semiautomatic welding gun are also electrically "hot".
- 3.d. Always be sure the work cable makes a good electrical connection with the metal being welded. The connection should be as close as possible to the area being welded.
- 3.e. Ground the work or metal to be welded to a good electrical (earth) ground.
- 3.f. Maintain the electrode holder, work clamp, welding cable and welding machine in good, safe operating condition. Replace damaged insulation.
- 3.g. Never dip the electrode in water for cooling.
- 3.h. Never simultaneously touch electrically "hot" parts of electrode holders connected to two welders because voltage between the two can be the total of the open circuit voltage of both welders.
- 3.i. When working above floor level, use a safety belt to protect yourself from a fall should you get a shock.
- 3.j. Also see Items 6.c. and 8.



ARC RAYS can burn.

- 4.a. Use a shield with the proper filter and cover plates to protect your eyes from sparks and the rays of the arc when welding or observing open arc welding. Headshield and filter lens should conform to ANSI Z87.1 standards.
- 4.b. Use suitable clothing made from durable flame-resistant material to protect your skin and that of your helpers from the arc rays.
- 4.c. Protect other nearby personnel with suitable, non-flammable screening and/or warn them not to watch the arc nor expose themselves to the arc rays or to hot spatter or metal.



FUMES AND GASES can be dangerous.

- 5.a. Welding may produce fumes and gases hazardous to health. Avoid breathing these fumes and gases. When welding, keep your head out of the fume. Use enough ventilation and/or exhaust at the arc to keep fumes and gases away from the breathing zone. **When welding with electrodes which require special ventilation such as stainless or hard facing (see instructions on container or MSDS) or on lead or cadmium plated steel and other metals or coatings which produce highly toxic fumes, keep exposure as low as possible and below Threshold Limit Values (TLV) using local exhaust or mechanical ventilation. In confined spaces or in some circumstances, outdoors, a respirator may be required. Additional precautions are also required when welding on galvanized steel.**
- 5.b. Do not weld in locations near chlorinated hydrocarbon vapors coming from degreasing, cleaning or spraying operations. The heat and rays of the arc can react with solvent vapors to form phosgene, a highly toxic gas, and other irritating products.
- 5.c. Shielding gases used for arc welding can displace air and cause injury or death. Always use enough ventilation, especially in confined areas, to insure breathing air is safe.
- 5.d. Read and understand the manufacturer's instructions for this equipment and the consumables to be used, including the material safety data sheet (MSDS) and follow your employer's safety practices. MSDS forms are available from your welding distributor or from the manufacturer.
- 5.e. Also see item 1.b.

Mar '95



WELDING SPARKS can cause fire or explosion.

6.a. Remove fire hazards from the welding area. If this is not possible, cover them to prevent the welding sparks from starting a fire.

Remember that welding sparks and hot materials from welding can easily go through small cracks and openings to adjacent areas. Avoid welding near hydraulic lines. Have a fire extinguisher readily available.

- 6.b. Where compressed gases are to be used at the job site, special precautions should be used to prevent hazardous situations. Refer to "Safety in Welding and Cutting" (ANSI Standard Z49.1) and the operating information for the equipment being used.
- 6.c. When not welding, make certain no part of the electrode circuit is touching the work or ground. Accidental contact can cause overheating and create a fire hazard.
- 6.d. Do not heat, cut or weld tanks, drums or containers until the proper steps have been taken to insure that such procedures will not cause flammable or toxic vapors from substances inside. They can cause an explosion even though they have been "cleaned". For information, purchase "Recommended Safe Practices for the Preparation for Welding and Cutting of Containers and Piping That Have Held Hazardous Substances", AWS F4.1 from the American Welding Society (see address above).
- 6.e. Vent hollow castings or containers before heating, cutting or welding. They may explode.
- 6.f. Sparks and spatter are thrown from the welding arc. Wear oil free protective garments such as leather gloves, heavy shirt, cuffless trousers, high shoes and a cap over your hair. Wear ear plugs when welding out of position or in confined places. Always wear safety glasses with side shields when in a welding area.
- 6.g. Connect the work cable to the work as close to the welding area as practical. Work cables connected to the building framework or other locations away from the welding area increase the possibility of the welding current passing through lifting chains, crane cables or other alternate circuits. This can create fire hazards or overheat lifting chains or cables until they fail.
- 6.h. Also see item 1.c.

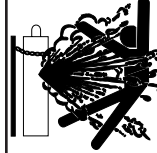

CYLINDER may explode if damaged.

7.a. Use only compressed gas cylinders containing the correct shielding gas for the process used and properly operating regulators designed for the gas and pressure used. All hoses, fittings, etc. should be suitable for the application and maintained in good condition.

- 7.b. Always keep cylinders in an upright position securely chained to an undercarriage or fixed support.
- 7.c. Cylinders should be located:
 - Away from areas where they may be struck or subjected to physical damage.
 - A safe distance from arc welding or cutting operations and any other source of heat, sparks, or flame.
- 7.d. Never allow the electrode, electrode holder or any other electrically "hot" parts to touch a cylinder.
- 7.e. Keep your head and face away from the cylinder valve outlet when opening the cylinder valve.
- 7.f. Valve protection caps should always be in place and hand tight except when the cylinder is in use or connected for use.
- 7.g. Read and follow the instructions on compressed gas cylinders, associated equipment, and CGA publication P-1, "Precautions for Safe Handling of Compressed Gases in Cylinders," available from the Compressed Gas Association 1235 Jefferson Davis Highway, Arlington, VA 22202.



FOR ELECTRICALLY powered equipment.

- 8.a. Turn off input power using the disconnect switch at the fuse box before working on the equipment.
- 8.b. Install equipment in accordance with the U.S. National Electrical Code, all local codes and the manufacturer's recommendations.
- 8.c. Ground the equipment in accordance with the U.S. National Electrical Code and the manufacturer's recommendations.

Mar '95

PRÉCAUTIONS DE SÛRETÉ

Pour votre propre protection lire et observer toutes les instructions et les précautions de sûreté spécifiques qui paraissent dans ce manuel aussi bien que les précautions de sûreté générales suivantes:

Sûreté Pour Soudage A L'Arc

1. Protégez-vous contre la secousse électrique:
 - a. Les circuits à l'électrode et à la pièce sont sous tension quand la machine à souder est en marche. Eviter toujours tout contact entre les parties sous tension et la peau nue ou les vêtements mouillés. Porter des gants secs et sans trous pour isoler les mains.
 - b. Faire très attention de bien s'isoler de la masse quand on soude dans des endroits humides, ou sur un plancher métallique ou des grilles métalliques, principalement dans les positions assis ou couché pour lesquelles une grande partie du corps peut être en contact avec la masse.
 - c. Maintenir le porte-électrode, la pince de masse, le câble de soudage et la machine à souder en bon et sûr état de fonctionnement.
 - d. Ne jamais plonger le porte-électrode dans l'eau pour le refroidir.
 - e. Ne jamais toucher simultanément les parties sous tension des porte-électrodes connectés à deux machines à souder parce que la tension entre les deux pinces peut être le total de la tension à vide des deux machines.
 - f. Si on utilise la machine à souder comme une source de courant pour soudage semi-automatique, ces précautions pour le porte-électrode s'appliquent aussi au pistolet de soudage.
2. Dans le cas de travail au dessus du niveau du sol, se protéger contre les chutes dans le cas où on reçoit un choc. Ne jamais enrouler le câble-électrode autour de n'importe quelle partie du corps.
3. Un coup d'arc peut être plus sévère qu'un coup de soleil, donc:
 - a. Utiliser un bon masque avec un verre filtrant approprié ainsi qu'un verre blanc afin de se protéger les yeux du rayonnement de l'arc et des projections quand on soude ou quand on regarde l'arc.
 - b. Porter des vêtements convenables afin de protéger la peau de soudeur et des aides contre le rayonnement de l'arc.
 - c. Protéger l'autre personnel travaillant à proximité au soudage à l'aide d'écrans appropriés et non-inflammables.
4. Des gouttes de laitier en fusion sont émises de l'arc de soudage. Se protéger avec des vêtements de protection libres de l'huile, tels que les gants en cuir, chemise épaisse, pantalons sans revers, et chaussures montantes.

5. Toujours porter des lunettes de sécurité dans la zone de soudage. Utiliser des lunettes avec écrans latéraux dans les zones où l'on pique le laitier.
6. Eloigner les matériaux inflammables ou les recouvrir afin de prévenir tout risque d'incendie dû aux étincelles.
7. Quand on ne soude pas, poser la pince à un endroit isolé de la masse. Un court-circuit accidentel peut provoquer un échauffement et un risque d'incendie.
8. S'assurer que la masse est connectée le plus près possible de la zone de travail qu'il est pratique de le faire. Si on place la masse sur la charpente de la construction ou d'autres endroits éloignés de la zone de travail, on augmente le risque de voir passer le courant de soudage par les chaînes de levage, câbles de grue, ou autres circuits. Cela peut provoquer des risques d'incendie ou d'échauffement des chaînes et des câbles jusqu'à ce qu'ils se rompent.
9. Assurer une ventilation suffisante dans la zone de soudage. Ceci est particulièrement important pour le soudage de tôles galvanisées plombées, ou cadmiées ou tout autre métal qui produit des fumées toxiques.
10. Ne pas souder en présence de vapeurs de chlore provenant d'opérations de dégraissage, nettoyage ou pistolage. La chaleur ou les rayons de l'arc peuvent réagir avec les vapeurs du solvant pour produire du phosgène (gas fortement toxique) ou autres produits irritants.
11. Pour obtenir de plus amples renseignements sur la sûreté, voir le code "Code for safety in welding and cutting" CSA Standard W 117.2-1974.

PRÉCAUTIONS DE SÛRETÉ POUR LES MACHINES À SOUDER À TRANSFORMATEUR ET À REDRESSEUR

1. Relier à la terre le châssis du poste conformément au code de l'électricité et aux recommandations du fabricant. Le dispositif de montage ou la pièce à souder doit être branché à une bonne mise à la terre.
2. Autant que possible, l'installation et l'entretien du poste seront effectués par un électricien qualifié.
3. Avant de faire des travaux à l'intérieur de poste, la débrancher à l'interrupteur à la boîte de fusibles.
4. Garder tous les couvercles et dispositifs de sûreté à leur place.

Thank You

for selecting a **QUALITY** product. We want you to take pride in operating this product ••• as much pride as we have in bringing this product to you!

Please Examine Carton and Equipment For Damage Immediately

When this equipment is shipped, title passes to the purchaser upon receipt by the carrier. Consequently, Claims for material damaged in shipment must be made by the purchaser against the transportation company at the time the shipment is received.

Please record your equipment identification information below for future reference. This information can be found on your machine nameplate.

Model Name & Number _____

Code & Serial Number _____

Date of Purchase _____

Whenever you request replacement parts for or information on this equipment always supply the information you have recorded above.

Read this Operators Manual completely before attempting to use this equipment. Save this manual and keep it handy for quick reference. Pay particular attention to the safety instructions we have provided for your protection. The level of seriousness to be applied to each is explained below:

⚠ WARNING

This statement appears where the information **must** be followed **exactly** to avoid **serious personal injury** or **loss of life**.

⚠ CAUTION

This statement appears where the information **must** be followed to avoid **minor personal injury** or **damage to this equipment**.

TABLE OF CONTENTS

	Page
SAFETY PRECAUTIONS	i-iv
INTRODUCTORY INFORMATION	vii
GENERAL DESCRIPTION	7
DESIGN FEATURES	7
SPECIFICATIONS.....	8-10
OPTIONAL EQUIPMENT.....	11
RECOMMENDED EQUIPMENT.....	12
INSTALLATION INSTRUCTIONS.....	13
Safety Precautions.....	13
Machine Grounding	13
Spark Arrester	13
Trailers.....	13-14
Pre-Operation Service	14
Oil	14
Fuel	14
Battery Connection.....	14
Welding Output Cables.....	14
Angle of Operation.....	15
High Altitude Operation.....	15
Muffler Relocation	15
Location / Ventilation	15
Connection of Lincoln Electric Wire Feeders	15
Connection of the LN-25 to the ZR-8	15
Connection of the LN-7 to the ZR-8	16
High Frequency Generator for TIG Welding Applications.....	16
OPERATING INSTRUCTIONS	16
Additional Safety Precautions.....	16
Welder Operation.....	16
Welder Output	16
ZR-8 Typical Fuel Consumption	16
Welder Controls - Function and Operation.....	17
Start/Shutdown Instructions	17
Break-in Period.....	18
Welding Process.....	18
Stick (Constant Current) Welding.....	18
TIG (Constant Current) Welding.....	18
Wire Feed Welding Processes (Constant Voltage)	19
Summary of Welding Process	19
Auxiliary Power	20
Electrical Device use with the ZR-8.....	21
Auxiliary Power While Welding.....	22
Standby Power Connection.....	22
Connecting ZR-8 to Premises Wiring	23
MAINTENANCE.....	24
Safety Precautions.....	24
Routine Maintenance.....	24
Engine Adjustments.....	24
Slip Rings.....	25
Battery	25
Hardware	25
Engine Maintenance Parts.....	25
TROUBLESHOOTING	26-27
Wiring Diagram.....	28,29
Connection Diagrams	30
Dimension Print	31
PARTS PAGES	P229 Series

GENERAL DESCRIPTION

The ZR-8 is a twin-cylinder, gasoline driven, multi-process arc welder and AC power generator. It is built in a heavy gauge steel case for durability on the job site.

DESIGN FEATURES

AC/DC STICK WELDING (Constant Current)

- AC 40 - 225 Amps
- DC 40 - 210 Amps
- 100% Duty Cycle on All Settings
- Output Selector with 6 Ranges
- Output Control for Fine Current Adjustment
- Use with a broad range of AC & DC Electrodes Including Fleetweld® 5P

DC SEMIAUTOMATIC WIRE FEED WELDING (Constant Voltage)

- CV Tap Setting for 60-200 Amps.
- 100% Duty Cycle.
- Excellent Performance with .068" (1.7mm) NR®-211-MP Innershield® Electrode.
- Limited MIG Welding with L-50 & L-56 using blended Argon Shielding Gas.
- The Recommended Wire Feeder is the LN-25, but Can Also be Used with the LN-7 Wire Feeder. (LN-7 and LN-25 without Contactor Requires the K240 Contactor Kit).

AC/DC TIG WELDING (Constant Current)

- AC & DC TIG Welding Can be Done at All Constant Current Output Range Settings.

AUXILIARY POWER

- 8000 Watt AC 115/230 Volt 60 Hz. Generator.
- Operates AC Power Tools.
- Powers Battery Chargers.
- Powers a 1.5 HP Motor (If Started Under No Load).
- Lights Eighty 100 Watt Incandescent Bulbs.
- Can be Used for Standby Power.

OTHER FEATURES

- Bottom Mounted 9 Gallon Fuel Tank with a Convenient Top Fill and Fuel Gauge.
- Polarity Switch for Selecting DC+, DC-, or AC Welding Output.

- K930-1 TIG Module Available.
- Remote Control Receptacle Kit Available.
- Electronic Engine Idler. Engine Automatically Goes to Low Idle in 10 to 14 Seconds after Welding or Use of Auxiliary Power. Includes High Idle Switch.
- Electric Starting.
- Battery Charging Ammeter.
- Full 8 kVA Auxiliary Output Receptacle.
- Factory Installed Engine Hour Meter.
- Engine Protection Shuts Engine Down in the Event of Low Oil Pressure.
- Built-in Feet for Easy Mounting to Truck Bed or Trailer.
- All Copper Alternator Windings and High Quality Insulation for Long-Life and Dependability.
- Powder Painted Case and Base for Outstanding Corrosion Protection.
- Quiet muffler with reversible exhaust feature; either right or left side of machine.

ENGINE

The Kohler 18 HP Command®* engine has the following features:

- Air Cooled, Twin-Cylinder.
- Cast Aluminum Alloy Crankcase with Integral Cast Iron Cylinder Liners.
- Electric Start with Solid State Battery Charging Module.
- Solid State Breakerless Ignition.
- Spin on Oil Filter.
- Low Oil Pressure Shutdown Protection.

Overhead valves and hydraulic valve lifters.

* The trademark is the property of their respective manufacturer.

SPECIFICATIONS

Machine

Product Name	Ordering Information	Description	Welding Output	Auxiliary Power	Dimensions & Weight
ZR-8	K1786-1 K1786-4	Multi-Purpose Arc Welder with 8,000 watts of Auxiliary Power	AC Constant Current 225A / 25V / 100% DC Constant Current 210A / 25V / 100% DC Constant Voltage 200A / 20V / 100%	8000 Watts, 60 Hz AC 70 Amps @ 115V 35 Amps @ 230V	30.3 x 19.2 x 42.3 in (765 x 460 x 1073 mm) 511 lbs (233 kg)

* Based on a 10 min. period.

Engine

Product Name	Description	Horsepower	Operating Speeds	Displacement	Capacities
<p>ZR-8 (Kohler Command CH20S)</p>	<p>2 Cylinder 4 Cycle Air-Cooled Gasoline Engine. Aluminum Alloy with Cast Iron Liners, Electrical Ignition</p>	<p>20 HP @ 3600 RPM</p>	<p>Full Load: 3500 RPM High Idle: 3700 RPM Low Idle: 2200 RPM</p>	<p>38.1 cu in (624 cc)</p>	<p>Fuel: 9 Gal (34 L) Lubricating Oil: 2.0 Qts (1.9 L)</p>

SPECIFICATIONS

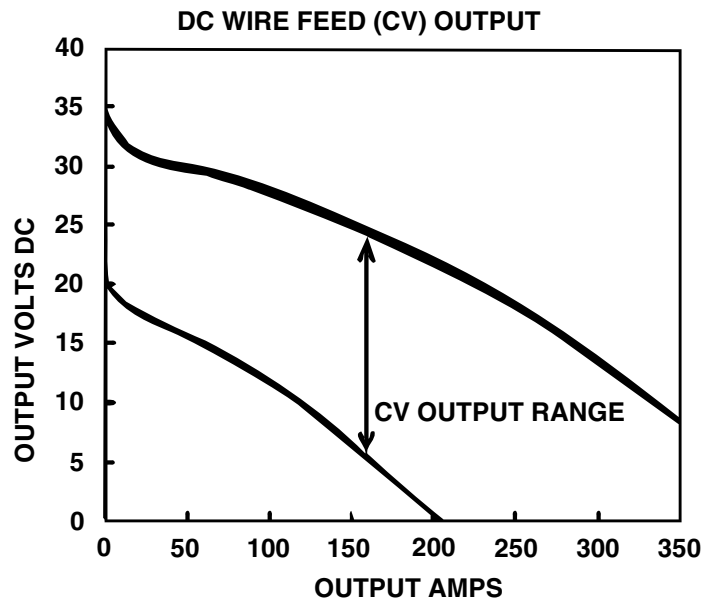
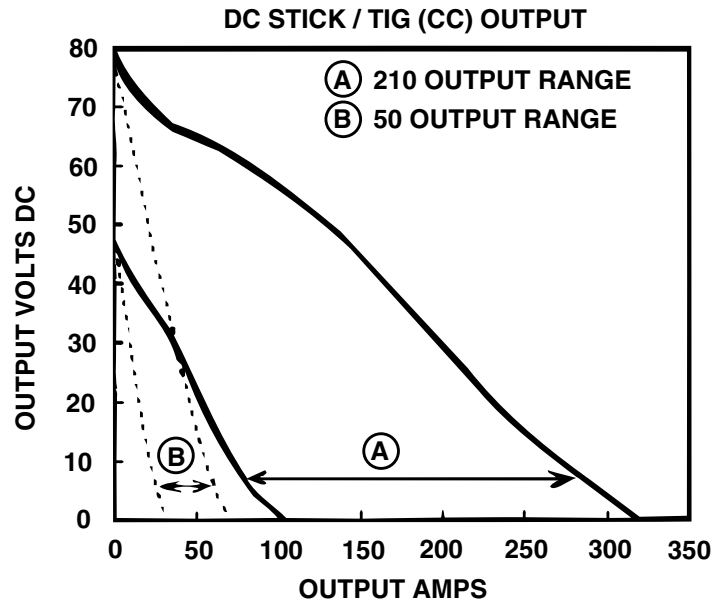
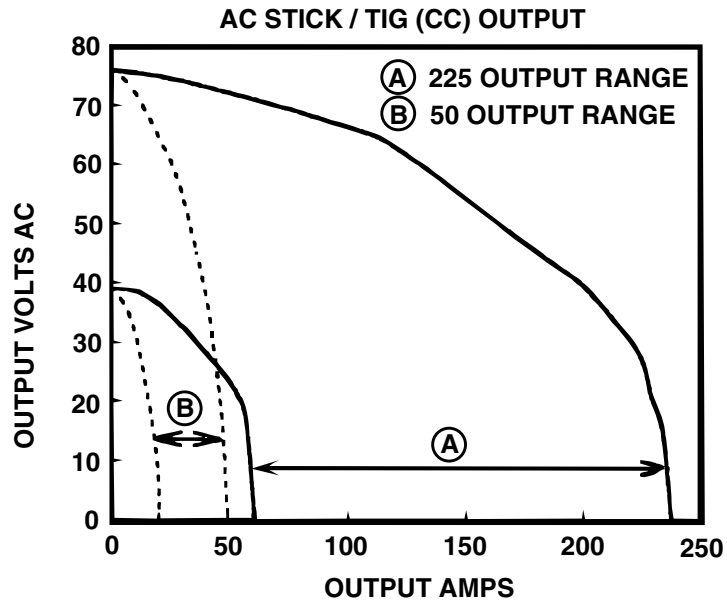

OPTIONAL EQUIPMENT (Field Installed)

Two-Wheel Trailer (K768-2) - For in-plant and yard towing. (For highway use, consult applicable federal, state, and local laws regarding possible requirements for brakes, lights, fenders, etc.)

Two-Wheel Undercarriage (K889-2) - For moving by hand. Overall Width 29 in (.74m)

Caster for Undercarriage (K893-1) - Mounts to the front of the K889-2 to allow easy movement on smooth surfaces. Includes 6" diameter hard rubber wheel and convenient toe-on, toe-off locking brake.

Canvas Cover (K886-1) - To protect the ZR-8 when not in use. Made from attractive red canvas material which is flame retardant, mildew resistant, and water repellent.

Power Plug Kit (K802-N) - Provides four 115V plugs rated at 20 amps each and one dual voltage, full kVA plug rated at 115/230V, 50 amps.

Power Plug Kit (K802-R) - Provides four 115V plugs rated at 15 amps each and one dual voltage, full kVA plug rated at 115/230V, 50 amps.

Accessory Kit (K710) - Includes 30 ft (9.1m) 3 AWG electrode cable, 25 ft. (7.6m) 3 AWG work cable, headshield with No. 12 filter, GC300 work clamp and Cooltong® 300 electrode holder. Cables are rated at 225 amps, 40% duty cycle.

Remote Control Receptacle Kit (K892-1) - Includes a 6-pin MS-type (Amphenol) receptacle and a local-remote toggle switch that mounts in the case front. Requires a Remote Control Option.

Remote Control (K857) - Consists of a control box with 25 ft. (7.5m) of four conductor cable. Permits remote adjustment of output voltage. (Requires Remote Control Receptacle Kit to be mounted in machine.)

Spark Arrester Kit (K894-1) - Includes a heavy gauge steel, approved spark arrester and clamp for easy mounting to muffler exhaust pipe.

GFCI Receptacle Kit (K896-1) - Includes two UL approved 115V ground fault circuit interrupter duplex type receptacles with covers and installation instructions. Replaces the two factory installed 115V duplex receptacles. Each receptacle of each GFCI duplex is rated at 15 amps, but the maximum total current from each GFCI duplex is limited to 20 amps.

TIG Module (K930-1) - Provides high frequency and shielding gas control for AC and DC GTAW (TIG) welding applications. Its compact case is designed for easy carrying, complete with a handle. High frequency bypass is built in. The K938-1 Contactor Kit must be field installed in the TIG Module when used with a ZR-8. Additionally, the K936-3 control cable is required if remote control is used. If remote control is not used the K936-4 control cable is required.

Remote Control Cable (K936-3) - Control cable for connecting the K930-1 TIG Module to a ZR-8 equipped with a K892-1 Remote Kit. 9-socket to a grounded 115 V plug and a 6 pin MS-connector. (Contains circuits 2, 4, 31, 32, 75, 76, 77 and ground)

Remote Control Cable (K936-4) - Control cable for connecting the K930-1 TIG Module to a ZR-8 not equipped with a K892-1 Remote Kit. 9-socket to a grounded 115 V plug and a 6 pin MS-connector. (Contains circuits 31, 32, and ground)

Docking Kit (K939-1) - For mounting the K930-1 TIG Module unit on top of the ZR-8.

Remote Control Receptacle Kit (K892-1) - Required when using a K930-1 TIG Module with and optional amptrol.

RECOMMENDED EQUIPMENT

STICK

Accessory Kit (K710) which includes:

- Electrode Holder & Cable
- Work Clamp & Cable
- Headshield

Remote Control Receptacle Kit (K892-1), and Remote Control Kit (K857) are optional for remote current control.

TIG

Magnum™ TIG Torch
Magnum Parts Kit and Argon Gas
TIG Module (K930-1) (requires K938-1 Contactor Kit)
Control Cable K939-3 or K939-4 (see Optional Equipment)

Optional:

- Docking Kit (K939-1)
- Hand Amptrol® (K963)
- Foot Amptrol (K870)
- Remote Control Receptacle Kit (K892-1)
- Adapter Cable (K915-1)

WIRE FEED

LN-25 (K449) - Includes internal contactor for across the arc operation (no control cable). Provides “cold” electrode until gun trigger is pressed. Includes gas solenoid. Remote control Receptacle Kit (K892-1) and Remote voltage Control Kit (K444-1) are required for voltage control at the feeder.

LN-7 - Contactor Kit (K240) is required.

Magnum Gun is required for gas-shielded welding.
Innershield Gun is required for gasless welding.

INSTALLATION INSTRUCTIONS

Safety Precautions

WARNING

Do not attempt to use this equipment until you have thoroughly read the engine manufacturer's manual supplied with your welder. It includes important safety precautions, detailed engine starting, operating and maintenance instructions, and parts lists.



ELECTRIC SHOCK can kill.

- Do not touch electrically live parts or electrode with skin or wet clothing.
- Insulate yourself from work and ground
- Always wear dry insulating gloves.



ENGINE EXHAUST can kill.

- Use in open, well ventilated areas or vent exhaust outside.



MOVING PARTS can injure.

- Do not operate with doors open or guards off.
- Stop engine before servicing.
- Keep away from moving parts.

See additional warning information at front of this operator's manual.

Machine Grounding

Because this portable engine driven welder or generator creates it's own power, it is not necessary to connect it's frame to an earth ground, unless the machine is connected to premises wiring (your home, shop, etc.).

To prevent dangerous electric shock, other equipment to which this engine driven welder supplies power must:

- a. **be grounded to the frame of the welder using a grounded type plug,** or
- b. **be double insulated.**

When this welder is mounted on a truck or trailer, it's frame must be securely connected to the metal frame of the vehicle.

Where this engine driven welder is connected to premises wiring such as that in your home or shop,

it's frame must be connected to the system earth ground. See further connection instructions in the section entitled "Standby Power Connections", as well as the article on grounding in the latest U.S. National Electrical Code and the local code.

In general, if the machine is to be grounded, it should be connected with a #8 or larger copper wire to a solid earth ground such as a metal water pipe going into the ground for at least ten feet and having no insulated joints, or to the metal framework of a building which has been effectively grounded. The U.S. National Electrical Code lists a number of alternate means of grounding electrical equipment. A machine grounding stud marked with the symbol  is provided on the front of the welder.

Spark Arrester

Some federal, state, or local laws may require that gasoline engines be equipped with exhaust spark arresters when they are operated in certain locations where unarrested sparks may present a fire hazard. The standard muffler included with this welder does not qualify as a spark arrester. When required by local regulations, the K894-1 spark arrester must be installed and properly maintained.

CAUTION

An incorrect arrester may lead to damage to the engine or adversely affect performance.

Trailers

The recommended trailer for use with this equipment for in plant and yard towing by a vehicle is Lincoln's K768-2. Consult applicable federal, state, and local laws regarding specific requirements for use on public highways.

If the user adapts a non-Lincoln trailer, he must assume responsibility that the method of attachment and usage does not result in a safety hazard nor damage the welding equipment.

Some of the factors to be considered are as follows:

1. Design capacity of trailer vs. weight of Lincoln equipment and likely additional attachments.
2. Proper support of, and attachment to, the base of the welding equipment so there will be no undue stress to the framework.

Pre-Operation Service

CAUTION

READ the engine operating and maintenance instructions supplied with this machine.

WARNING



GASOLINE fuel can cause fire or explosion.

- Stop engine while fueling.
- Do not smoke when fueling.
- Do not overfill tank.
- Keep sparks and flame away from tank.
- Wipe up spilled fuel and allow fumes to clear before starting engine.

Oil

The ZR-8 is shipped with the engine crankcase filled with SAE 10W-30 oil. Check the oil level before starting the engine. If it is not up to the full mark on the dip stick, add oil as required. Make certain that the oil filler cap is tightened securely. Refer to the engine Owner's Manual for specific oil recommendations.

LUBRICATION SYSTEM CAPACITY
(INCLUDING FILTER)
Kohler CH20S - 2.0 Quarts (1.9 Liters)

Fuel



Fill the fuel tank with clean, fresh, lead-free gasoline. Observe fuel gauge while filling to prevent overfilling.

Battery Connections

This welder is shipped with the negative battery cable disconnected. Make sure that the Engine Switch is in the "STOP" position and attach the disconnected cable securely to the negative battery terminal before attempting to operate the machine. If the battery is discharged and does not have enough power to start the engine, see the battery charging instructions in the Battery section.

Welding Output Cables

With the engine off, connect the electrode and work cables to the studs provided. These connections should be checked periodically and tightened if necessary. Loose connections will result in overheating of the output studs.

When welding at a considerable distance from the welder, be sure you use ample size welding cables. Listed below are copper cable sizes recommended for the rated current and duty cycle. Lengths stipulated are the distance from the welder to work and back to the welder again. Cable sizes are increased for greater lengths primarily for the purpose of minimizing cable voltage drop.

TOTAL COMBINED LENGTH OF ELECTRODE AND WORK CABLES		
	225 Amps 40% Duty Cycle	225 Amps 100% Duty Cycle
0-50 Ft.	3 AWG	1 AWG
50-100 Ft.	3 AWG	1 AWG
100-150 Ft.	2 AWG	1 AWG
150-200 Ft.	1 AWG	1 AWG
200-250 Ft.	1/0 AWG	1/0 AWG

Angle of Operation

Internal combustion engines are designed to run in a level condition which is where the optimum performance is achieved. The maximum angle of operation for the engine is 15 degrees from horizontal in any direction. If the engine is to be operated at an angle, provisions must be made for checking and maintaining the oil at the normal (FULL) oil capacity in the crankcase in a level condition.

When operating at an angle, the effective fuel capacity will be slightly less than the specified 10 gallons.

High Altitude Operation

If the ZR-8 will be consistently operated at altitudes above 5000 ft, a carburetor jet designed for high altitudes should be installed. This will result in better fuel economy, cleaner exhaust, and longer spark plug life. It will not give increased power which is decreased at higher altitudes. Engine horsepower is reduced by 3.5% per 1000 feet for altitudes above 377 feet.

CAUTION

Do not operate a ZR-8 with a high altitude jet installed at altitudes below 5000 ft. This will result in the engine running too lean and result in higher engine operating temperatures which can shorten engine life.

High altitude jet kits are available from the engine manufacturer. For Kohler order kit part no. 2475501.

Muffler Relocation

WARNING

Shut off welder and allow muffler to cool before touching muffler.

The ZR-8 is shipped with the exhaust coming out on the left side. The exhaust can be changed to the opposite side by removing the two screws that hold the exhaust port cover in place and installing the cover on the opposite side. (Operating the ZR-8 without the cover in place will result in a higher noise level and no increase in machine output.)

Location / Ventilation

The welder should be located to provide an unrestricted flow of clean, cool air to the cooling air inlets and to avoid heated air coming out of the welder recirculating back to the cooling air inlet. Also, locate the welder so that engine exhaust fumes are properly vented to an outside area.

WARNING



- **Damage to the fuel tank may cause fire or explosion. Do not drill holes in the ZR-8 base or weld to the ZR-8 base.**

Connection of Lincoln Electric Wire Feeders

WARNING

Shut off welder before making any electrical connections.

Wire Feed (Constant voltage)

Connection of the LN-25 to the ZR-8

- a. Shut the welder off.
- b. Connect the electrode cable from the LN-25 to the "ELECTRODE" terminal of the welder. Connect the work cable to the "TO WORK" terminal of the welder.
- c. Position the welder "Polarity" switch to the desired polarity, either DC (-) or DC (+).
- d. Position the "RANGE" switch to the "WIRE FEED" position.
- e. Attach the single lead from the LN-25 control box to the work using the spring clip on the end of the lead - it carries no welding current.
- f. Place the idler switch in the "AUTO" position.
- g. Adjust wire feed speed at the LN-25 and adjust the welding voltage with the output "CONTROL" at the welder.

NOTE: The welding electrode is energized at all times, unless an LN-25 with built-in contactor is used. If the output "CONTROL" is set below "3", the LN-25 contactor may not pull in.

Connection of the LN-7 to the ZR-8

- a. Shut the welder off.
- b. Connect the LN-7 and the K240 contactor kit per instructions on the connection diagram S17742 (can be found in the back of this manual).
- c. Place the “RANGE” switch to the “WIRE FEED” position and the “POLARITY” switch to the desired polarity.
- d. Place the “IDLER” switch in the “HIGH” idle position. The engine idling device may not function when welding in the “WIRE FEED” mode.
- e. Adjust wire feed speed at the LN-7 and adjust the welding voltage with the output “CONTROL” at the welder.

NOTE: If the output “CONTROL” is set below “3” the K240 contactor may not pull in.

Connection of K930-1 TIG Module to the ZR-8.

The TIG Module is an accessory that provides high frequency and shielding gas control for AC and DC GTAW (TIG) welding. See IM528 supplied with the TIG Module for installation instructions.

Note: The TIG Module does not require the use of a high frequency bypass capacitor. However, if the ZR-8 is used with any other high frequency equipment, the bypass capacitor must be installed - order kit T12246.

OPERATING INSTRUCTIONS

Additional Safety Precautions

Always operate the welder with the roof and case sides in place as this provides maximum protection from moving parts and assures proper cooling air flow.

Read and understand all Safety Precautions before operating this machine. Always follow these and any other safety procedures included in this manual and in the Engine Owner’s Manual.

Welder Operation

Welder Output

- Maximum Open Circuit Voltage at 3700 RPM is 80 Volts RMS.
- Duty Cycle: 100% for both welding and auxiliary power.

ZR-8	
Constant Current	225 Amps AC @ 25 Volts 210 Amps DC @ 25 Volts
Constant Voltage	200 Amps DC @ 20 Volts

ZR-8 Approximate Fuel Consumption

	KOHLER 20 H.P. COMMAND
Low Idle - No Load 2200 RPM	.4 Gallons/Hour (1.5 Liters/Hour)
High Idle - No Load 3700 RPM	.9 Gallons/Hour (3.5 Liters/Hour)
AC CC Weld Output 225 Amps @ 25 Volts	1.3 Gallons/Hour (5.0 Liters/Hour)
DC CC Weld Output 210 Amps @ 25 Volts	1.4 Gallons/Hour (5.3 Liters/Hour)
DC CV Weld Output 200 Amps @ 20 Volts	1.2 Gallons/Hour (4.5 Liters/Hour)
Auxiliary Power 8000 Watts	1.4 Gallons/Hour (5.3 Liters/Hour)

Welder Controls - Function and Operation

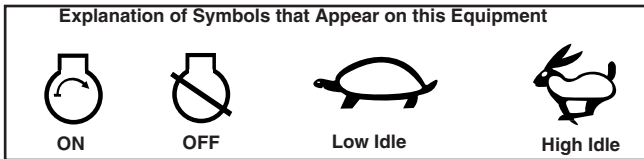

ENGINE “ON-OFF” Switch

When placed in the “ON” position, this switch energizes the engine ignition circuit. When placed in the “OFF” position, the ignition circuit is de-energized to shut down the engine.

ENGINE “START” Push-Button Switch

Energizes engine starter motor.

“Polarity” Switch



Never change the “Polarity” switch setting while welding. This will damage the switch.

“Range” Switch

Process	Maximum Current on Each Setting
STICK/TIG - CC 6 Range Settings	50, 70, 90 125, 175, 210 DC/225 AC
WIRE FEED - CV 1 Range Setting	200



Never change the “RANGE” Switch setting while welding. This will damage the switch.

“Control” Switch

Provides a fine welding current adjustment within the Range Switch settings in the STICK/TIG mode and welding voltage control with the Range switch set in the wire feed mode.

“IDLER” Switch

The idler switch has two positions, “HIGH” and “AUTO”.

When in “HIGH” () position, the engine will run continuously at high idle.

When in “AUTO” (/) idle position, the idler operates as follows:

a. Welding

When the electrode touches the work, the welding arc is initiated and the engine accelerates to full speed.

After welding ceases (and no auxiliary power is being drawn), the engine will return to low idle after approximately 10 to 14 seconds.

b. Auxiliary Power

With the engine running at low idle and auxiliary power for lights or tools is drawn (approximately 100-150 watts or greater) from the receptacles, the engine will accelerate to high speed. If no power is being drawn from the receptacles (and not welding) for 10-14 seconds, the idler reduces the engine speed to low idle.

Starting/Shutdown Instructions

Starting the Engine



- Do not touch electrically live parts of electrode with skin or wet clothing.



- Keep flammable material away.



- Insulate yourself from work and ground. Wear eye, ear, and body protection.



- Keep your head out of the fumes.
- Use ventilation or exhaust to remove fumes from breathing zone.

Be sure all Pre-Operation Maintenance has been performed. Also, read the Engine Owner’s Manual.

Remove all loads connected to the AC power receptacles. To start the engine, set the “Idler Control” switch in the Automatic (/) position.

Use the choke control as follows:

Kohler Engine - Always pull the choke control out when starting the engine; cold, warm or hot. Place the “Engine” switch in the “ON” position.

Push the “START” button and crank the engine until it starts. Release the button as soon as the engine starts. Do not push the “START” button while the engine is running because this will cause damage to the ring gear and/or starter motor. After the engine has started, slowly return the choke control to the full “in” position (choke open).

After running at high engine speed for 10-14 seconds, the engine will go to low idle.

Allow the engine to warm up by letting it run at low idle for a few minutes.

Stopping the Engine

Remove all welding and auxiliary power loads and allow engine to run at low idle speed for a few minutes to cool the engine.

Stop the engine by placing the “Engine” switch in the “OFF” position.

A fuel shut off valve is not required on the ZR-8 because the fuel tank is mounted below the engine.

Break-in Period

It is normal for any engine to use a greater amount of oil until the break-in is accomplished. Check the oil level twice a day during the break-in period (approximately 50 running hours).

IMPORTANT: IN ORDER TO ACCOMPLISH THIS BREAK-IN, THE UNIT SHOULD BE SUBJECTED TO MODERATE LOADS, WITHIN THE RATING OF THE MACHINE. AVOID LONG IDLE RUNNING PERIODS. REMOVE LOADS AND ALLOW ENGINE TO COOL BEFORE SHUTDOWN.

The engine manufacturer’s recommendation for the running time until the first oil change is as follows:

Kohler CH20S
5 hr

The oil filter is to be changed at the second oil change. Refer to the Engine Owner’s Manual for more information.

Welding Process

Stick (Constant Current) Welding

Connect welding cables to the “TO WORK” and “ELECTRODE” studs. Start the engine. Set the “Polarity” switch to the desired polarity. Set the “RANGE” switch to a setting that is equal to or slightly greater than the desired welding current. (The “RANGE” dial marking indicates the maximum current for that range). Fine adjustment of the welding current is made by adjusting the output “CONTROL” or remote control. **For best arc stability, use settings 5 through 10.**

The ZR-8 can be used with a broad range of AC and DC stick electrodes. See “Welding Tips 1” included with the ZR-8 for electrodes within the rating of this unit and recommended welding currents of each.

TIG (Constant Current) Welding

The K930-1 TIG Module installed on a ZR-8 provides high frequency and shielding gas control for AC and DC GTAW (TIG) welding processes. The TIG Module allows full range output control. Afterflow time is adjustable from 0 to 55 seconds.

When using the ZR-8 for AC TIG welding of aluminum, the following settings and electrodes are recommended:

SETTINGS FOR PURE TUNGSTEN		
TUNGSTEN DIAMETER (in.)	RANGE SWITCH SETTINGS	APPROXIMATE CURRENT RANGE
1/8	70, 90, or 125	80 - 150 Amps
3/32	50, 70, or 90	45 - 130 Amps
1/16	50, or 70	40 - 80 Amps
SETTINGS FOR 1% THORIATED TUNGSTEN		
TUNGSTEN DIAMETER (in.)	RANGE SWITCH SETTINGS	APPROXIMATE CURRENT RANGE
1/8	70, 90, 125, or 175	80 - 225 Amps
3/32	50, 70, 90, or 125	50 - 180 Amps
1/16	50, 70, or 90	45 - 120 Amps

The K930-1 TIG Module should be used with the ZR-8 on high idle to maintain satisfactory operation. It can be used in the AUTO position but the delay going to flow idle after welding is ceased will be increased if the AFTERFLOW CONTROL is set above 10 seconds

The ZR-8 is recommended for limited "MIG" welding (GMAW - gas metal arc welding). The recommended electrodes are .030" and .035" L-50 and L-56. They must be used with a blended shielding gas such as C25 (75% Argon - 25% CO₂). The welding ranges that can be used with the ZR-8 are shown in the following table:

**Wire Feed Welding Processes
(Constant Voltage)**

The only Innershield[®] electrode recommended for use with the ZR-8 is NR[®]-211-MP. The electrode sizes and welding ranges that can be used with the ZR-8 are shown in the following table:

Diameter (in.)	Wire Speed Range In./Min.	Approximate Current Range
.030	80 - 110	75A to 120A
.035	70 - 130	120A to 170A

Diameter (in.)	Wire Speed Range In./Min.	Approximate Current Range
.035	80 - 110	75A to 120A
.045	70 - 130	120A to 170A
.068	40 - 90	125A to 210A

Summary of Welding Processes

PROCESS	CONTROL CABLE USED	IDLE MODE	ELECTRODE WHEN NOT WELDING	TO START WELDING
STICK	No	AUTO	Hot	Touch electrode to work. Welding starts immediately and engine goes to high idle.
TIG/K7930-1/K938-1, K936-() /K892-1 (WITH AMPCTRL)	Yes	HIGH	Cold	Press Ampctrl, contactor closes, welding starts immediately.
WIRE FEED, LN-25 WITH INTERNAL CONTACTOR	No	AUTO	Cold	Press gun trigger, LN-25 contactor closes. Welding starts immediately and engine goes to high idle. NOTE: Output Control must be set above "3".
WIRE FEED, LN-7 WITH K240 CONTACTOR KIT	Yes	HIGH	Cold	Press gun trigger, contactor closes. Welding starts immediately.

Auxiliary Power

The ZR-8 can provide up to 8,000 watts of 115/230 volts AC, single phase 60Hz power for continuous use. The front of the machine includes three receptacles for connecting the AC power plugs; one 50 amp 115/230 volt NEMA 14-50R receptacle and two 20 amp 115 volt NEMA 5-20R receptacles.

CAUTION

Do not connect any plugs that connect to the power receptacles in parallel.

Start the engine and set the "IDLER" control switch to the desired operating mode. Set the "CONTROL" to 10. Voltage is now correct at the receptacles for auxiliary power.

115/230 Volt Dual Voltage Receptacle

The 115/230 volt receptacle can supply up to 35 amps of 230 volt power to a two wire circuit, up to 35 amps of 115 volts power from each side of a three wire circuit (up to 70 amps total). Do not connect the 115 volt circuits in parallel. Current sensing for the automatic idle feature is only in one leg of the three wire circuit as shown below.

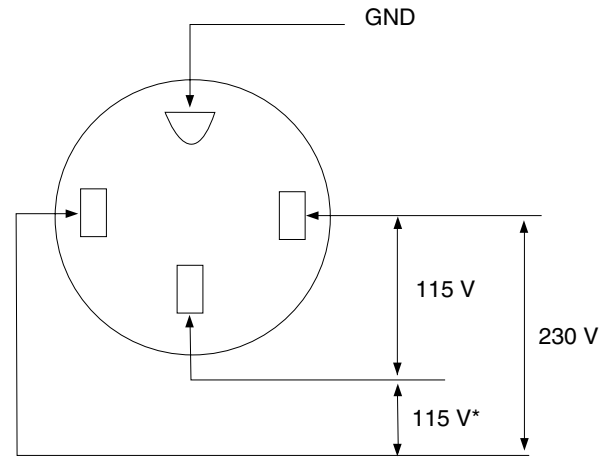

*Current Sensing for Automatic Idle.
(Receptacle viewed from front of Machine)

115 V Duplex Receptacles

The 115V auxiliary power receptacles should only be used with three wire grounded type plugs or approved double insulated tools with two wire plugs.

The current rating of any plug used with the system must be at least equal to the current load through the associated receptacle (Refer to Tables I and II). Do not attempt to connect power receptacles in parallel.

Motor Starting

Most 1.5 hp AC single phase motors can be started if there is no load on the motor or other load connected to the machine, since the full load current rating of a 1.5 hp motor is approximately 20 amperes (10 amperes for 230 volt motors). The motor may be run at full load when plugged into only one side of the duplex receptacle. Larger motors through 2 hp can be run provided the receptacle rating as previously stated is not exceeded. This may necessitate 230V operation only.

TABLE I Maximum Current Draw from 115V Duplex Receptacles - No Welding

Load From 115V/230V Dual Voltage Receptacle		
	Each 115V Duplex	Total From Both 115V Duplexes
0	20*	40
1.1 KW	20*	40
3.4 KW	20*	40
5.7 KW	20*	20
8.0 KW	0	0

*NEMA 5-20P Plug required for 20Amp Draw

TABLE II Maximum Current Draw from 115V GFCI Duplex Receptacles - No Welding

Load From 115V/230V Dual Voltage Receptacle		
	Each 115V Duplex	Total From Both 115V Duplexes
0	20	40*
1.1 KW	20	40*
3.4 KW	20	40*
5.7 KW	20	20*
8.0 KW	0	0

*Maximum current draw from each 115V GFCI Duplex is 20 amps

**TABLE III
ELECTRICAL DEVICE USE WITH THE ZR-8**

Type	Common Electrical Devices	Possible Concerns
Resistive	Heaters, toasters, incandescent light bulbs, electric range, hot pan, skillet, coffee maker.	NONE
Capacitive	TV sets, radios, microwaves, appliances with electrical control.	Voltage spikes or high voltage regulation can cause the capacitive elements to fail. Surge protection, transient protection, and additional loading is recommended for 100% fail-safe operation. DO NOT RUN THESE DEVICES WITHOUT ADDITIONAL RESISTIVE TYPE LOADS.
Inductive	Single-phase induction motors, drills, well pumps, grinders, small refrigerators, weed and hedge trimmers	These devices require large current inrush for starting. Some synchronous motors may be frequency sensitive to attain maximum output torque, but they SHOULD BE SAFE from any frequency induced failures.
Capacitive/Inductive	Computers, high resolution TV sets, complicated electrical equipment.	An inductive type line conditioner along with transient and surge protection is required, and liabilities still exist. DO NOT USE THESE DEVICES WITH A ZR-8.

The Lincoln Electric Company is not responsible for any damage to electrical components improperly connected to the ZR-8

Auxilliary Power While Welding

It must be noted that the above auxiliary power ratings are with no welding load. Simultaneous welding and power loads are permitted by following Table III. The permissible currents shown assume that current is being drawn from either the 115V or 230V supply (not both at the same time). Also, the "Output Control" is set at "10" for maximum auxiliary power.

TABLE III SIMULTANEOUS WELDING AND POWER			
Output Selector Setting	Permissible Power Watts (Unity Power Factor)	Permissible Auxiliary Current in Amperes @ 115V -or- @ 230V	
Max. Stick or Wire Feed Setting	None	0	0
175 Stick Setting	2100	18	9
125 Stick Setting	3800	32	16
90 Stick Setting	5000	42	21
70 Stick Setting	5600	48	24
50 Stick Setting	6300	54	27
NO WELDING	8000	70	35

1. Install a double pole, double throw switch between the power company meter and the premises disconnect.

Switch rating must be the same or greater than the customer's premises disconnect and service overcurrent protection.

2. Take necessary steps to assure load is limited to the capacity of the ZR-8 by installing a 35 amp 230V double pole circuit breaker. Maximum rated load for the 230V auxiliary is 35 amperes. Loading above 35 amperes will reduce output voltage below the allowable -10% of rated voltage which may damage appliances or other motor-driven equipment.
3. Install a 50 amp 115/230V plug (NEMA type 14-50) to the Double Pole Circuit Breaker using No. 8, 4 conductor cable of the desired length. (The 50 amp 115/230V plug is available in the optional plug kit.)
4. Plug this cable into the 50 amp 115/230V receptacle on the ZR-8 case front.

Standby Power Connections

The ZR-8 is suitable for temporary, standby, or emergency power using the engine manufacturer's recommended maintenance schedule.

The ZR-8 can be permanently installed as a standby power unit for 230V-3 wire, single phase 35 ampere service.

WARNING

(Connections must be made by a licensed electrician who can determine how the 115/230V power can be adapted to the particular installation and comply with all applicable electrical codes.) The following information can be used as a guide by the electrician for most applications (refer also to the connection diagram shown in Figure 1.)

Figure 1

CONNECTION OF ZR-8 TO PREMISES WIRING

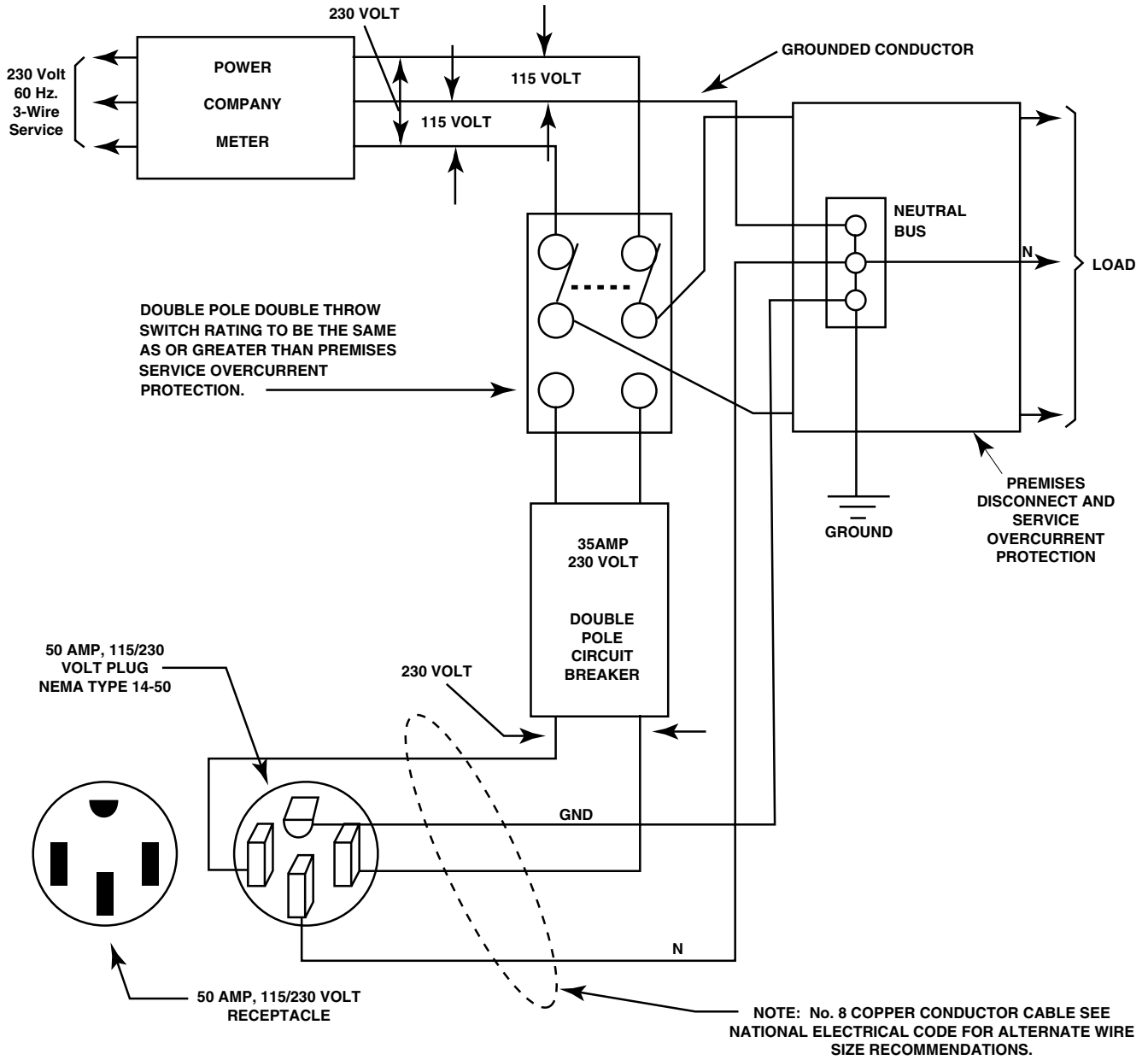

⚠ WARNING

Connection of ZR-8 to premises wiring must be done by a licensed electrician and must comply with the National Electrical Code and all other applicable electrical codes.

MAINTENANCE

Safety Precautions

WARNING

- **Have qualified personnel do maintenance and troubleshooting work.**
- **Turn the engine off before working inside the machine.**
- **Remove guards only when necessary to perform maintenance, and replace them when the maintenance requiring their removal is complete.**
- **If guards are missing from a machine, obtain replacements from a Lincoln Distributor. (See Operating Manual Parts List.)**

Read the Safety Precautions in the front of this manual and the engine instruction manual before working on this machine.

Keep all equipment safety guards, covers, and devices in position and in good repair. Keep hands, hair, clothing, and tools away from gears, fans, and all other moving parts when starting, operating, or repairing the equipment.

Routine Maintenance

1. At the end of each day's use, refill the fuel tank to minimize moisture condensation in the tank. Running out of fuel tends to draw dirt into the fuel system. Also, check the crankcase oil level and add oil if indicated.

CAUTION

Make certain that the oil filler cap is securely tightened after checking or adding oil. If the cap is not tight, oil consumption can increase significantly which may be evidenced by white smoke coming from the exhaust.

2. OIL - Maintenance schedule for changing the oil and oil filter after break-in:

	Kohler CH20S
Oil	100 hr
Oil Filter	200 hr

The above schedule is for normal operating conditions. More frequent oil changes are required with dusty, high temperature and other severe operating conditions. Refer to the maintenance section of the Engine Owner's Manual for more information.

NOTE: Engine life will be reduced if the oil and oil filter are not changed according to the manufacturer's recommendation.

3. Air Cleaner - With normal operating conditions, the maintenance schedule for cleaning and re-oiling the foam pre-filter is every 25 hours and replacement of the air cleaner filter every 100 hours. More frequent servicing is required with dusty operating conditions. Refer to the maintenance section of the Engine Owner's Manual for more information.
4. Refer to the maintenance section of the Engine Owner's Manual for the maintenance schedule, spark plug servicing, cooling system servicing, and fuel filter replacement.
5. Blow out the machine with low pressure air periodically. In particularly dirty locations, this may be required once a week.
6. Output Ranger Selector and Polarity Switches: Switch contacts should not be greased. To keep contacts clean, rotate the switch through its entire range frequently. Good practice is to turn the handle from maximum to minimum setting twice each morning before starting to weld.

Engine Adjustments

OVERSPEED IS HAZARDOUS

WARNING

The maximum allowable high idle speed for this machine is 3750 RPM, no load. Do NOT tamper with governor components or setting or make any other adjustments to increase the maximum speed. Severe personal injury and damage to the machine can result if operated at speeds above maximum.

Adjustments to the engine are to be made only by a Lincoln Service Center or an authorized Field Service Shop.

Slip Rings

A slight amount of darkening and wear of the slip rings and brushes is normal. Brushes should be inspected when a general overhaul is necessary. If brushes are to be replaced, clean slip rings with a fine emery paper.

CAUTION

Do not attempt to polish slip rings while engine is running.

Battery

WARNING

GASES FROM BATTERY can explode.

- Keep sparks, flame and cigarettes away from battery.



To prevent EXPLOSION when:

- **INSTALLING A NEW BATTERY** - disconnect negative cable from old battery first and connect to new battery last.



- **CONNECTING A BATTERY CHARGER** - Remove battery from welder by disconnecting negative cable first, then positive cable and battery clamp. When re-installing, connect negative cable last. Keep well ventilated.



- **USING A BOOSTER** - connect positive lead to battery first then connect negative lead to engine foot.

BATTERY ACID CAN BURN EYES AND SKIN.

- Wear gloves and eye protection and be careful when working near battery. Follow instructions printed on battery.

1. When replacing, jumping, or otherwise connecting the battery to the battery cables, the proper polarity must be observed. Failure to observe the proper polarity could result in damage to the charging circuit. The positive (+) battery cable has a red terminal cover.
2. If the battery requires charging from an external charger, disconnect the negative battery cable first and then the positive battery cable before attaching the charger leads. Failure to do so can result in damage to the internal charger components. When reconnecting the cables, connect the positive cable first and the negative cable last.

Hardware

Both English and Metric fasteners are used in this welder.

Engine Maintenance Parts

Oil Filter	KOHLER CH20S KOHLER 1205001 FRAM PH3614*
Air Filter Element	KOHLER 4708303 FRAM CA79
Air Filter Pre-Cleaner	KOHLER 2408302
Fuel Filter	KOHLER 2505002 FRAM G1
Spark Plugs (Resistor Type)	CHAMPION RC12YC (.030" GAP)

* Oil capacity increases from 2.0 Qts. to 2.1 Qts. when using this filter.

TROUBLESHOOTING

TROUBLE	CAUSE	WHAT TO DO
<p>A. No welder or output power.</p>	<ol style="list-style-type: none"> 1. Open in miscellaneous leads. 2. Open lead in flashing or field circuit. 3. Faulty rotor. 4. Faulty Potentiometer (R1). 5. Faulty stator Field winding. 6. Faulty Field rectifier (D2). 7. Faulty P.C. Board. 	<ol style="list-style-type: none"> 1. Refer to wiring diagram & check related leads. 2. Refer to wiring diagram and check all related leads (200, 224, 200A, 200B, 201, 201A). 3. Lift brushes and check rotor resistance between slip rings. It should be approximately 4 ohms. 4. Replace with known good one. 5. Disconnect lead #9 at D2 and check for continuity between leads #9 and #7. 6. Replace with known good one. 7. Replace with known good one.
<p>B. Engine will not idle down to low speed.</p>	<ol style="list-style-type: none"> 1. Idler switch on High Idle. 2. Insufficient voltage present between terminals #213 and #5E. (Voltage should be 12V DC). 3. External load on welder or auxiliary power. 4. Faulty wiring in solenoid circuit. 5. Faulty idler solenoid. 6. Faulty P.C. Board. 	<ol style="list-style-type: none"> 1. Set switch on Automatic Idler. 2. Check for proper connection of leads (#213, #5E, #215, #209, #209A, #224, #224A). 3. Remove all external loads and short circuits. 4. Check for broken leads #213 and #215. 5. Replace with known good one. 6. Replace P.C. Board with known good one.
<p>C. Engine will not go to high idle when attempting to weld.</p>	<ol style="list-style-type: none"> 1. Poor work lead connection to work. 2. No voltage signal from the current sensor. 3. No open circuit voltage on output studs. 4. Faulty P.C. Board. 	<ol style="list-style-type: none"> 1. Make certain work clamp is tightly connected to clean base metal. 2. Check for disconnected or broken leads in idler sensing circuit. 3. Check generator output. 4. Replace P.C. Board with known good one.

TROUBLESHOOTING

TROUBLE	CAUSE	WHAT TO DO
D. Engine will not go to high idle when using auxiliary power.	<ol style="list-style-type: none"> 1. No voltage signal from the current sensor. 2. Auxiliary power load less than 100 to 150 watts. 3. Faulty P.C. Board 	<ol style="list-style-type: none"> 1. Check for disconnected or broken leads in idler sensing circuit. 2. Idler may not function with less than 100 to 150 watt load. Set idler switch to high idle. 3. Replace P.C. Board with known good one.
E. Engine will not crank or is hard to crank.	<ol style="list-style-type: none"> 1. Battery will not hold a charge. Faulty Battery. 2. No or insufficient charging current. 3. Loose battery cable connection(s). 	<ol style="list-style-type: none"> 1. Replace with known good one. 2. Check the connection of the lead from the voltage regulator on the engine to the charging ammeter and the battery. 3. Check and tighten connection at battery, at starter, at engine foot, or at frame.
F. Engine shuts down.	<ol style="list-style-type: none"> 1. Out of fuel. 2. Low oil level. 	<ol style="list-style-type: none"> 1. Add fuel. 2. Check oil level and add oil as required.
G. Engine does not develop full power.	<ol style="list-style-type: none"> 1. Fuel filter clogged. 2. Air filter clogged. 	<ol style="list-style-type: none"> 1. Replace. 2. Replace.
H. Engine is hard to start.	<ol style="list-style-type: none"> 1. Spark plugs do not have specified gap. 2. Spark plugs are fouled. 	<ol style="list-style-type: none"> 1. Adjust to specified gap. 2. Replace spark plugs (See Engine Owner's Manual).

K1786-1 Code 10706 (ONLY) ZR-8 KOHLER - Wiring Diagram

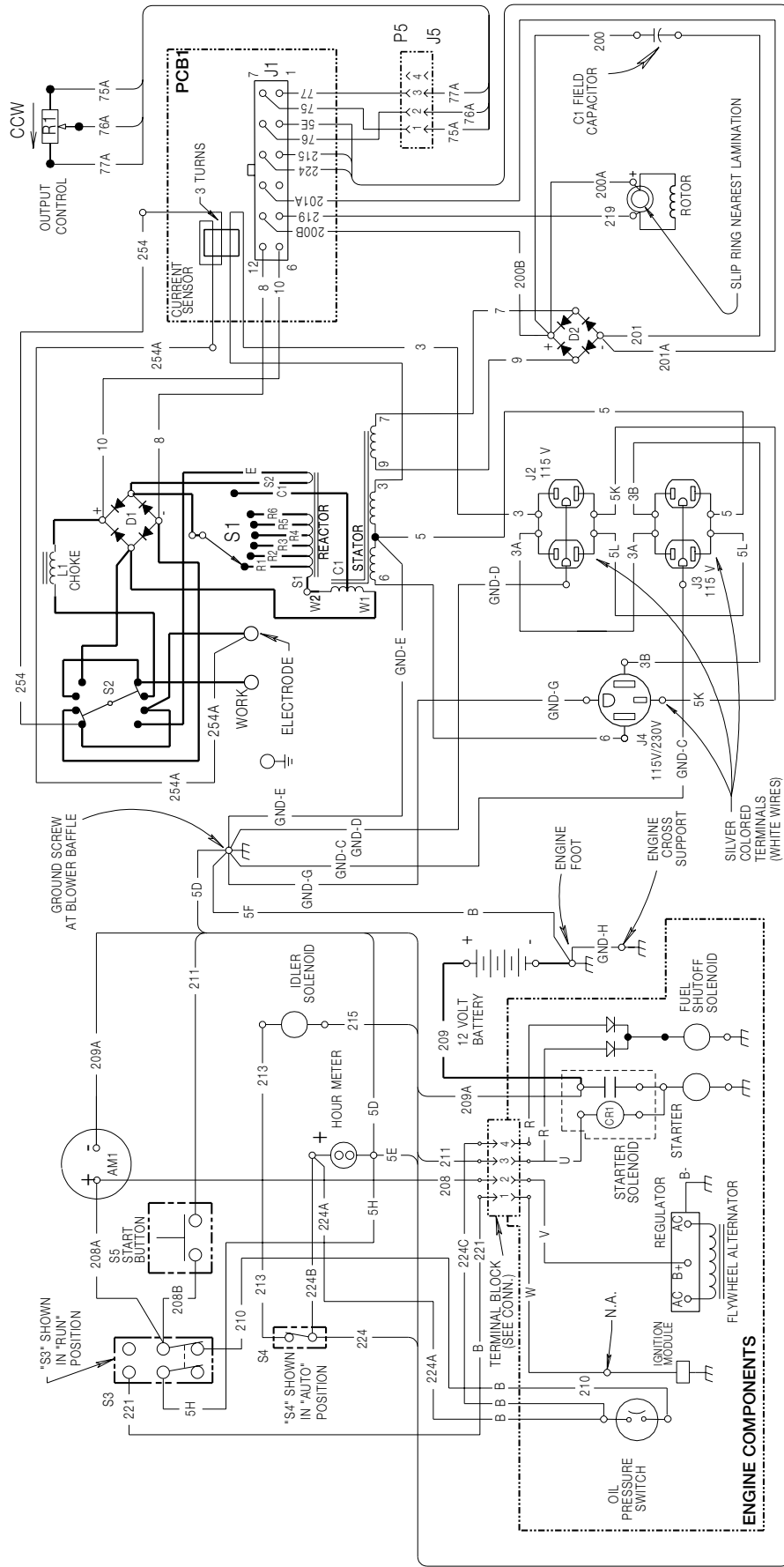

N.A. GROUNDING THIS TERMINAL STOPS THE ENGINE.

LEAD COLOR CODE:

- B = BLACK
- R = RED
- W = WHITE
- U = BLUE
- V = VIOLET

CONNECTOR PIN NUMBERS:

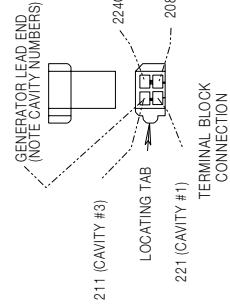
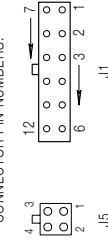

ALL CASE FRONT COMPONENTS SHOWN VIEWED FROM REAR.

ELECTRICAL SYMBOLS PER E1537

7-19-986

M18333

NOTE: This diagram is for reference only. It may not be accurate for all machines covered by this manual. The specific diagram for a particular code is pasted inside the machine on one of the enclosure panels. If the diagram is illegible, write to the Service Department for a replacement. Give the equipment code number..

K1786-4 CODE 10938 (ONLY) ZR-8 KOHLER -WIRING DIAGRAM

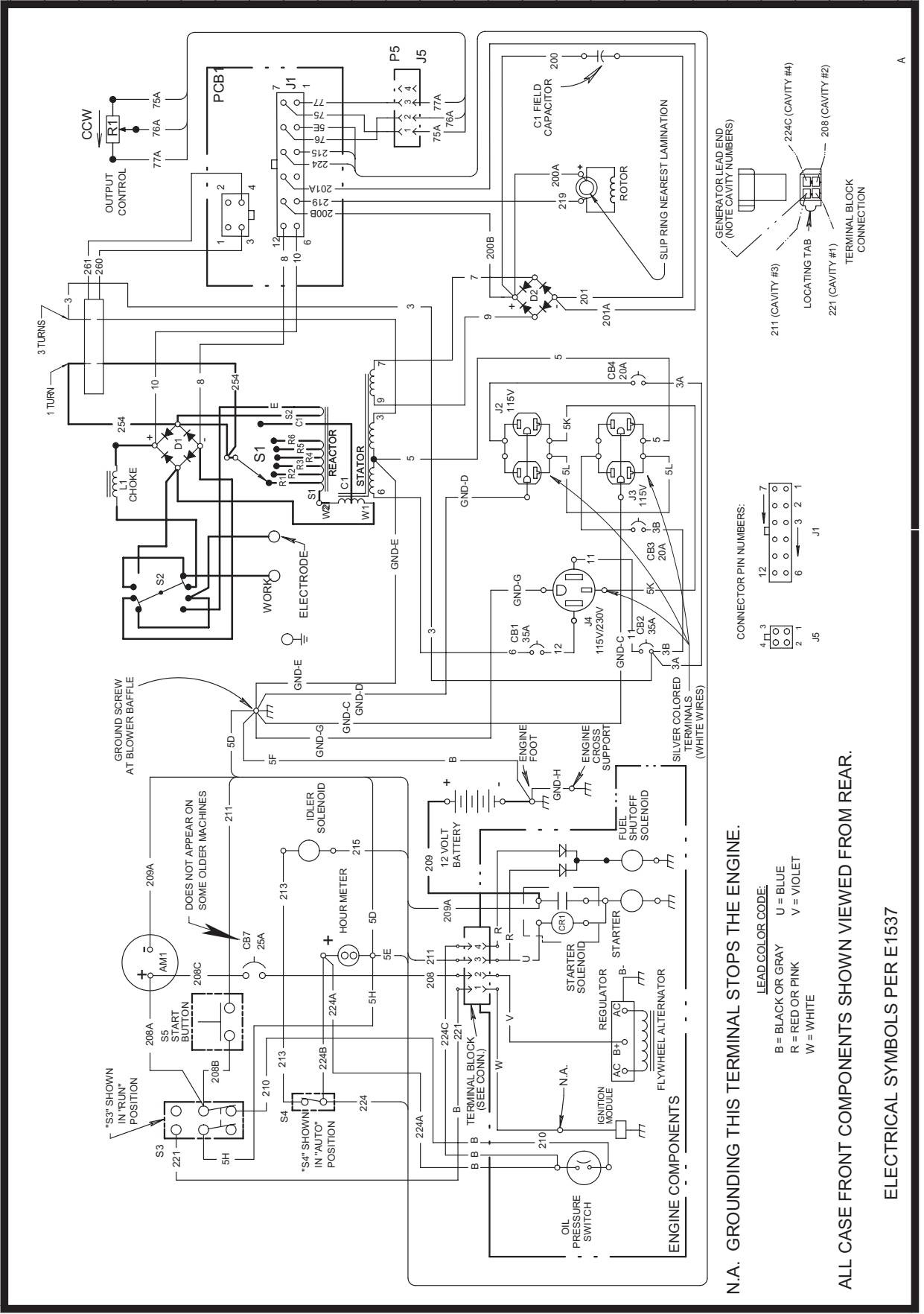

N.A. GROUNDING THIS TERMINAL STOPS THE ENGINE.

LEAD/COLOR CODE:
 B = BLACK OR GRAY U = BLUE
 R = RED OR PINK V = VIOLET
 W = WHITE

ALL CASE FRONT COMPONENTS SHOWN VIEWED FROM REAR.

ELECTRICAL SYMBOLS PER E1537

NOTE: This diagram is for reference only. It may not be accurate for all machines covered by this manual. The specific diagram for a particular code is pasted inside the machine on one of the enclosure panels. If the diagram is illegible, write to the Service Department for a replacement. Give the equipment code number..

ZR-8 / LN-25 ACROSS THE ARC CONNECTION DIAGRAM

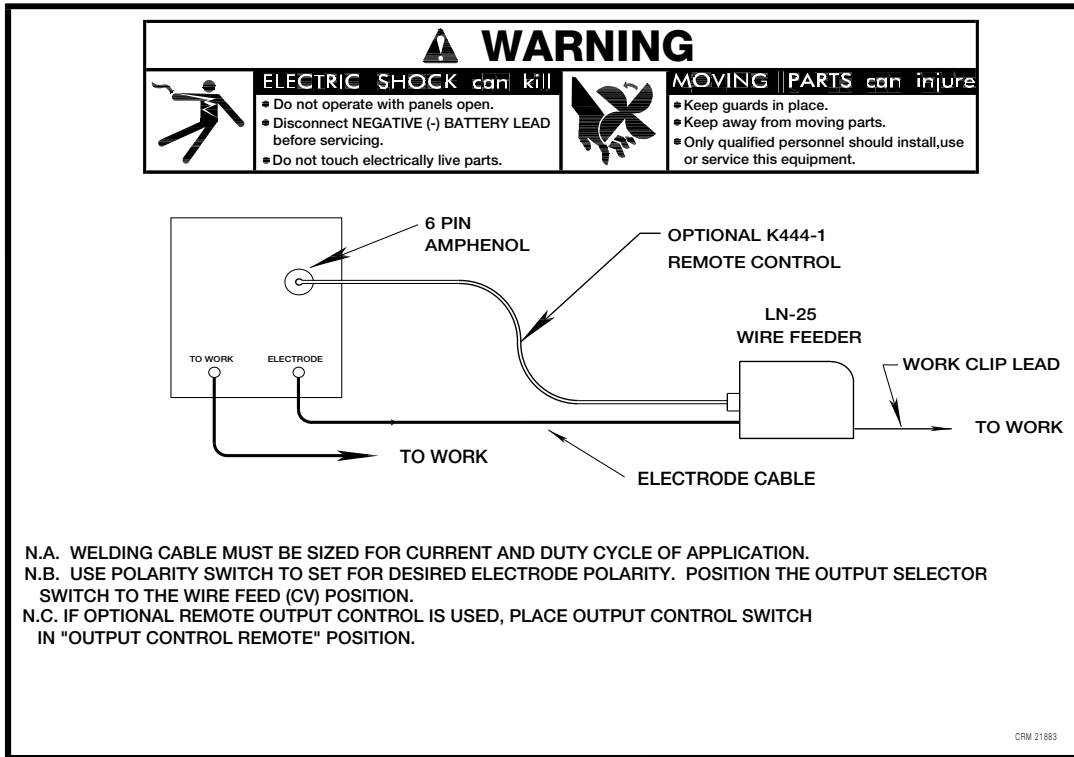

CONNECTION OF ZR-8 TO LN-7 & K240 CONTACTOR KIT

CONNECTION OF LN-7 & K240 CONTACTOR KIT WITH 115 VOLT AC AUXILIARY POWER AND CV OUTPUT

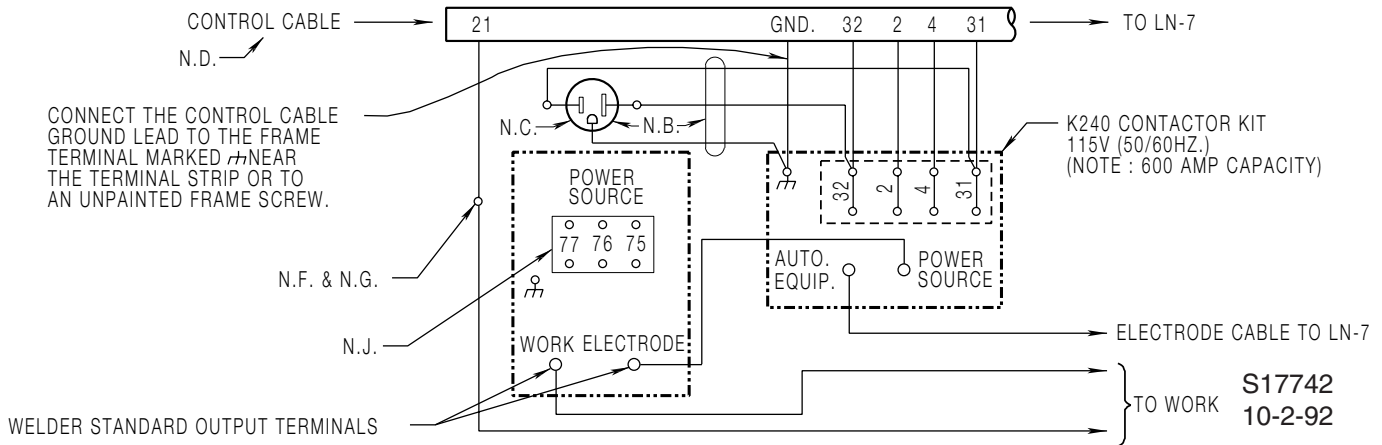

WARNING: Turn the power off when making connections.

- N.A. Use power source polarity switch to set for desired electrode polarity. Position the output selector switch on the power source to the CV position.
- N.B. 3 conductor #16 power cord physically suitable for the installation and plug rated at 115 volts 15 amperes AC.
- N.C. Plug into 115 volt AC receptacle on welder control panel or other 115 volt AC supply rated at a minimum of 500 volt-amperes.
- N.D. Leads #21 and GND. do not appear on LN-7's with codes below 7026.
- N.E. Welding cables must be of proper capacity for the current and duty cycle of immediate and future applications.
- N.F. If LN-7 is equipped with a meter kit, extend lead #21 using #14 or larger insulated wire physically suitable for the installation. An S16586-"length" remote voltage sensing work lead

may be ordered for this purpose. Connect it directly to the work piece independent of the welding work cable. For convenience, this extended #21 lead should be taped to the welding work lead.

- N.G. Tape up bolted connection where lead #21 is extended.
- N.H. Idler switch on power source must be in high idle position.
- N.J. If an optional remote output control is used, connect it to this terminal strip or 6 pin Amphenol receptacle. NOTE: Terminal strip or 6 pin Amphenol receptacle not available on all power sources.

CAUTION: Any speed up of the engine RPM by changing the governor setting or over-riding the throttle linkage will cause an increase in the AC auxiliary voltage. If this voltage goes above 140 volts, the LN-7 control circuit will be damaged. The engine governor setting is pre-set at the factory - do not adjust above RPM specifications listed in engine welder operating manual.

DIMENSION PRINT - ZR-8 (Kohler)

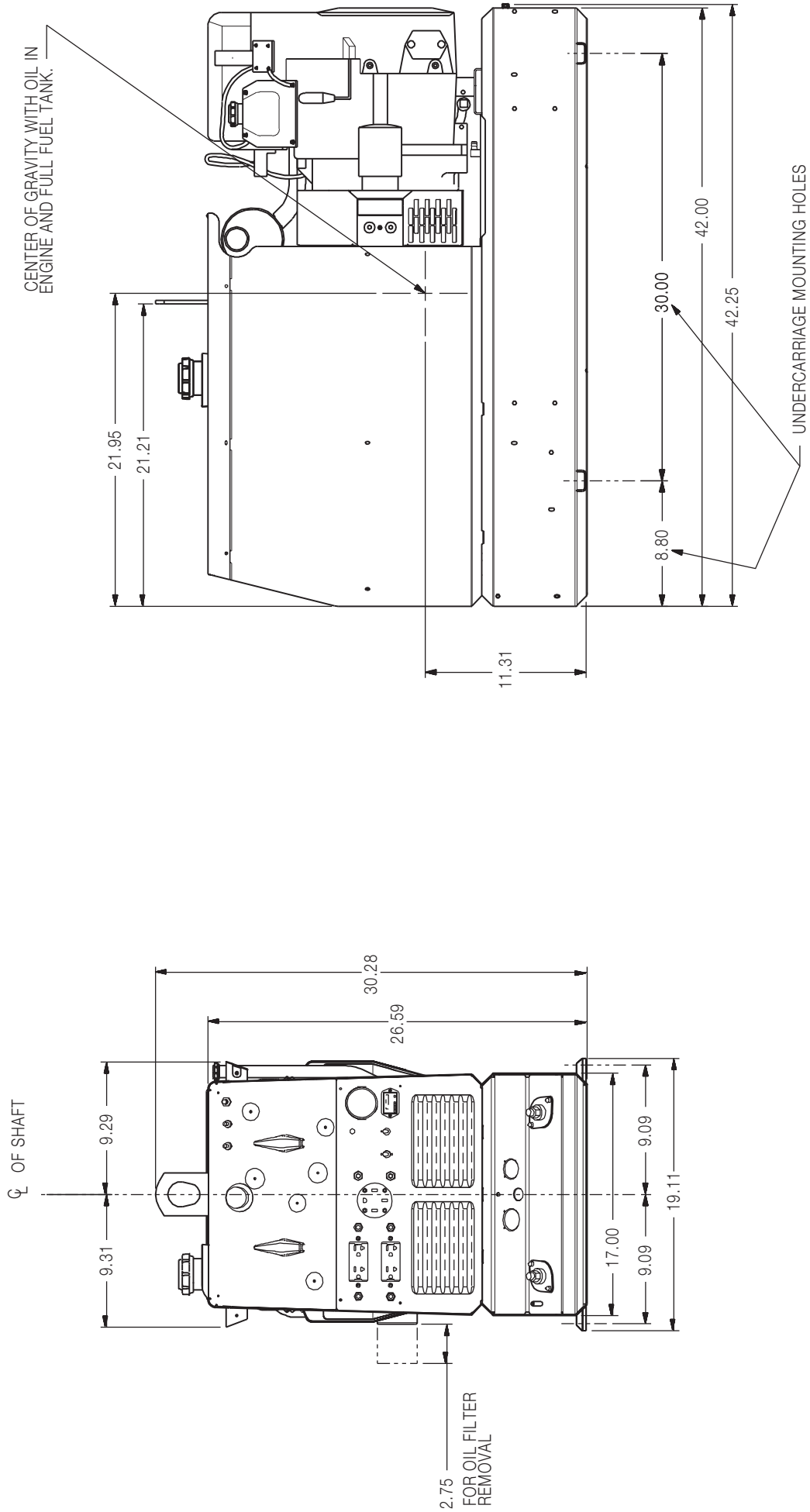

WARNING	<ul style="list-style-type: none"> ● Do not touch electrically live parts or electrode with skin or wet clothing. ● Insulate yourself from work and ground. 	<ul style="list-style-type: none"> ● Keep flammable materials away. 	<ul style="list-style-type: none"> ● Wear eye, ear and body protection.
Spanish AVISO DE PRECAUCION	<ul style="list-style-type: none"> ● No toque las partes o los electrodos bajo carga con la piel o ropa mojada. ● Aíslese del trabajo y de la tierra. 	<ul style="list-style-type: none"> ● Mantenga el material combustible fuera del área de trabajo. 	<ul style="list-style-type: none"> ● Protéjase los ojos, los oídos y el cuerpo.
French ATTENTION	<ul style="list-style-type: none"> ● Ne laissez ni la peau ni des vêtements mouillés entrer en contact avec des pièces sous tension. ● Isolez-vous du travail et de la terre. 	<ul style="list-style-type: none"> ● Gardez à l'écart de tout matériel inflammable. 	<ul style="list-style-type: none"> ● Protégez vos yeux, vos oreilles et votre corps.
German WARNUNG	<ul style="list-style-type: none"> ● Berühren Sie keine stromführenden Teile oder Elektroden mit Ihrem Körper oder feuchter Kleidung! ● Isolieren Sie sich von den Elektroden und dem Erdboden! 	<ul style="list-style-type: none"> ● Entfernen Sie brennbares Material! 	<ul style="list-style-type: none"> ● Tragen Sie Augen-, Ohren- und Körperschutz!
Portuguese ATENÇÃO	<ul style="list-style-type: none"> ● Não toque partes elétricas e electrodos com a pele ou roupa molhada. ● Isole-se da peça e terra. 	<ul style="list-style-type: none"> ● Mantenha inflamáveis bem guardados. 	<ul style="list-style-type: none"> ● Use proteção para a vista, ouvido e corpo.
Japanese 注意事項	<ul style="list-style-type: none"> ● 通電中の電気部品、又は溶材にヒフやぬれた布で触れないこと。 ● 施工物やアースから身体が絶縁されている様にして下さい。 	<ul style="list-style-type: none"> ● 燃えやすいものの側での溶接作業は絶対にしてはなりません。 	<ul style="list-style-type: none"> ● 目、耳及び身体に保護具をして下さい。
Chinese 警告	<ul style="list-style-type: none"> ● 皮膚或濕衣物切勿接觸帶電部件及鎢條。 ● 使你自己與地面和工件絕緣。 	<ul style="list-style-type: none"> ● 把一切易燃物品移離工作場所。 	<ul style="list-style-type: none"> ● 佩戴眼、耳及身體勞動保護用具。
Korean 위험	<ul style="list-style-type: none"> ● 전도체나 용접봉을 젖은 헝겍 또는 피부로 절대 접촉치 마십시오. ● 모재와 접지를 접촉치 마십시오. 	<ul style="list-style-type: none"> ● 인화성 물질을 접근시키지 마십시오. 	<ul style="list-style-type: none"> ● 눈, 귀와 몸에 보호장구를 착용하십시오.
Arabic تحذير	<ul style="list-style-type: none"> ● لا تلمس الاجزاء التي يسري فيها التيار الكهربائي أو الألكترود بجسد الجسم أو بالملابس المبللة بالماء. ● ضع عازلا على جسمك خلال العمل. 	<ul style="list-style-type: none"> ● ضع المواد القابلة للاشتعال في مكان بعيد. 	<ul style="list-style-type: none"> ● ضع أدوات وملابس واقية على عينيك وأذنيك وجسمك.

READ AND UNDERSTAND THE MANUFACTURER'S INSTRUCTION FOR THIS EQUIPMENT AND THE CONSUMABLES TO BE USED AND FOLLOW YOUR EMPLOYER'S SAFETY PRACTICES.

SE RECOMIENDA LEER Y ENTENDER LAS INSTRUCCIONES DEL FABRICANTE PARA EL USO DE ESTE EQUIPO Y LOS CONSUMIBLES QUE VA A UTILIZAR, SIGA LAS MEDIDAS DE SEGURIDAD DE SU SUPERVISOR.

LISEZ ET COMPRENEZ LES INSTRUCTIONS DU FABRICANT EN CE QUI REGARDE CET EQUIPMENT ET LES PRODUITS A ETRE EMPLOYES ET SUIVEZ LES PROCEDURES DE SECURITE DE VOTRE EMPLOYEUR.

LESEN SIE UND BEFOLGEN SIE DIE BETRIEBSANLEITUNG DER ANLAGE UND DEN ELEKTRODENEINSATZ DES HERSTELLERS. DIE UNFALLVERHÜTUNGSVORSCHRIFTEN DES ARBEITGEBERS SIND EBENFALLS ZU BEACHTEN.

			
<ul style="list-style-type: none"> ● Keep your head out of fumes. ● Use ventilation or exhaust to remove fumes from breathing zone. 	<ul style="list-style-type: none"> ● Turn power off before servicing. 	<ul style="list-style-type: none"> ● Do not operate with panel open or guards off. 	WARNING
<ul style="list-style-type: none"> ● Los humos fuera de la zona de respiración. ● Mantenga la cabeza fuera de los humos. Utilice ventilación o aspiración para gases. 	<ul style="list-style-type: none"> ● Desconectar el cable de alimentación de poder de la máquina antes de iniciar cualquier servicio. 	<ul style="list-style-type: none"> ● No operar con panel abierto o guardas quitadas. 	Spanish AVISO DE PRECAUCION
<ul style="list-style-type: none"> ● Gardez la tête à l'écart des fumées. ● Utilisez un ventilateur ou un aspirateur pour ôter les fumées des zones de travail. 	<ul style="list-style-type: none"> ● Débranchez le courant avant l'entretien. 	<ul style="list-style-type: none"> ● N'opérez pas avec les panneaux ouverts ou avec les dispositifs de protection enlevés. 	French ATTENTION
<ul style="list-style-type: none"> ● Vermeiden Sie das Einatmen von Schweißrauch! ● Sorgen Sie für gute Be- und Entlüftung des Arbeitsplatzes! 	<ul style="list-style-type: none"> ● Strom vor Wartungsarbeiten abschalten! (Netzstrom völlig öffnen; Maschine anhalten!) 	<ul style="list-style-type: none"> ● Anlage nie ohne Schutzgehäuse oder Innenschutzverkleidung in Betrieb setzen! 	German WARNUNG
<ul style="list-style-type: none"> ● Mantenha seu rosto da fumaça. ● Use ventilação e exaustão para remover fumo da zona respiratória. 	<ul style="list-style-type: none"> ● Não opere com as tampas removidas. ● Desligue a corrente antes de fazer serviço. ● Não toque as partes elétricas nuas. 	<ul style="list-style-type: none"> ● Mantenha-se afastado das partes moventes. ● Não opere com os painéis abertos ou guardas removidas. 	Portuguese ATENÇÃO
<ul style="list-style-type: none"> ● ヒュームから頭を離すようにして下さい。 ● 換気や排煙に十分留意して下さい。 	<ul style="list-style-type: none"> ● メンテナンス・サービスに取りかかる際には、まず電源スイッチを必ず切ってください。 	<ul style="list-style-type: none"> ● パネルやカバーを取り外したまま機械操作をしないで下さい。 	Japanese 注意事項
<ul style="list-style-type: none"> ● 頭部遠離煙霧。 ● 在呼吸區使用通風或排風器除煙。 	<ul style="list-style-type: none"> ● 維修前切斷電源。 	<ul style="list-style-type: none"> ● 儀表板打開或沒有安全罩時不準作業。 	Chinese 警告
<ul style="list-style-type: none"> ● 얼굴로부터 용접가스를 멀리하십시오. ● 호흡지역으로부터 용접가스를 제거하기 위해 가스제거기나 통풍기를 사용하십시오. 	<ul style="list-style-type: none"> ● 보수전에 전원을 차단하십시오. 	<ul style="list-style-type: none"> ● 판넬이 열린 상태로 작동치 마십시오. 	Korean 위험
<ul style="list-style-type: none"> ● ابعد رأسك بعيداً عن الدخان. ● استعمل التهوية أو جهاز ضغط الدخان للخارج لكي تبعد الدخان عن المنطقة التي تتنفس فيها. 	<ul style="list-style-type: none"> ● أقطع التيار الكهربائي قبل القيام بأية صيانة. 	<ul style="list-style-type: none"> ● لا تشغيل هذا الجهاز اذا كانت الاغطية الحديدية الواقية ليست عليه. 	Arabic تحذير

LEIA E COMPREENDA AS INSTRUÇÕES DO FABRICANTE PARA ESTE EQUIPAMENTO E AS PARTES DE USO, E SIGA AS PRÁTICAS DE SEGURANÇA DO EMPREGADOR.

使う機械や溶材のメーカーの指示書をよく読み、まず理解して下さい。そして貴社の安全規定に従って下さい。

請詳細閱讀並理解製造廠提供的說明以及應該使用的銀焊材料，並請遵守貴方的有閣勞動保護規定。

이 제품에 동봉된 작업지침서를 숙지하시고 귀사의 작업자 안전수칙을 준수하시기 바랍니다.

اقرأ بتمعن وافهم تعليمات المصنع المنتج لهذه المعدات والمواد قبل استعمالها واتبع تعليمات الوقاية لصاحب العمل.



• World's Leader in Welding and Cutting Products •

• Sales and Service through Subsidiaries and Distributors Worldwide •

— Cleveland, Ohio 44117-1199 U.S.A. TEL: 216.481.8100 FAX: 216.486.1751 WEB SITE: www.lincolnelectric.com

